

MU-IP1613 / 3213 MU-IP1624 / 3224



Matrix Cat6 IP KVM Benefits

- ▶ Secure IP remote user access across the world wide web
- ▶ Efficient system management with simultaneous multi-user access
- ▶ Capable of connecting 32 or 16 servers per device in 1U
- ▶ Support DVI-USB, VGA-USB & VGA-PS/2 server interface
- ▶ Up to 40 meters between your server & KVM switch
- ▶ Enhanced Cat6 cable management with remote access up to 150m

Switch Features & Options

- Provide a diversity of console to access servers independently and simultaneously
- Use of the RJ45 Cat6 interface allows for a higher number of ports in smaller density
- Greater distances between your switch and servers allow enhanced data center rack layouts
- Multi lingual on screen display menu
- Advanced user profiles and configurable OSD hot key combinations

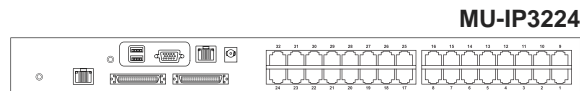
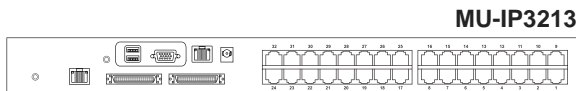
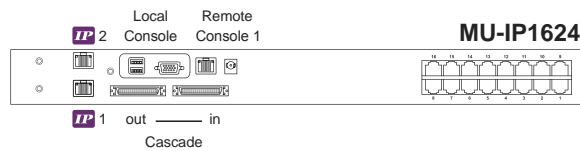
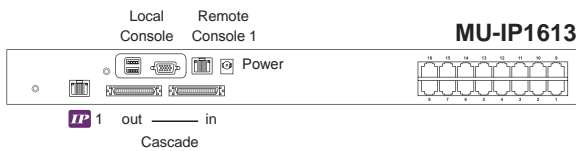

Ordering Information

Console	Local	Remote	IP	16-port	32-port
	1	1	1	MU-IP1613	MU-IP3213
	1	1	2	MU-IP1624	MU-IP3224

KVM Specification

■ KVM Port Number of ports: 16 or 32 Connector: RJ-45 Connectivity: DVI-D / VGA connector dongle up to 40 meters (132 feet) via Cat6 / Cat5 cable	
■ Local Console Monitor port: DB15-pin VGA Keyboard & mouse port: 2 x USB type connector for keyboard & mouse Resolution support: 4:3 - max. 1600 x 1200 16:10 - max. 1440 x 900	
■ Cat6 Remote Console Number of remote port: 1 Monitor port: DB15-pin VGA Keyboard & mouse port: 2 x USB type connector for keyboard & mouse Remote I/O: RJ45 via Cat5 / Cat5e / Cat6 cable up to 500 feet Resolution support: 4:3 - max. 1600 x 1200 16:10 - max. 1440 x 900	
■ IP Remote Console Number of IP console: 1 for MU-IP1613 / MU-IP3213 2 for MU-IP1624 / MU-IP3224 User management: 15-user login, 1 x active user Browser: Internet Explorer, Firefox, Safari Security: SSL v3, RSA, AES, HTTP / HTTPS, CSR IP Access: RJ45 Ethernet per IP console Resolution support: 4:3 - max. 1600 x 1200	

■ Expansion: Up to 256 servers by 8-level cascade	
■ Compatibility Multi-platform: Mix PCs, SUN and Mac G3 / G4 Mac / iMac Support: Windows 7 / Vista / 2003 / XP, Linux, Unix	
■ Power Input: AC power adapter Consumption: Max. 48 Watt, Standby 5 Watt	
■ Regulatory : Safety: cUL, FCC & CE certified Environment: RoHS2 & REACH compliant	
■ Environmental Operating: 0 to 50°C Storage: -5 to 60°C Relative humidity: 90%, non-condensing Shock: 50G peak acceleration (11ms, half-sine wave) Vibration: 58~100Hz / 0.98G (11ms / cycle)	
■ Product Information Dimension (W x D x H): 443 x 171 x 44 mm / 17.4 x 6.7 x 1.73 inch Net weight: 3 kg / 6.5 lb	
■ Packing Information Dimension (W x D x H): 500 x 400 x 90 mm / 19.7 x 15.7 x 3.5 inch Gross weight: 5 kg / 11 lb	

KVM port & Cat6 dongle connection

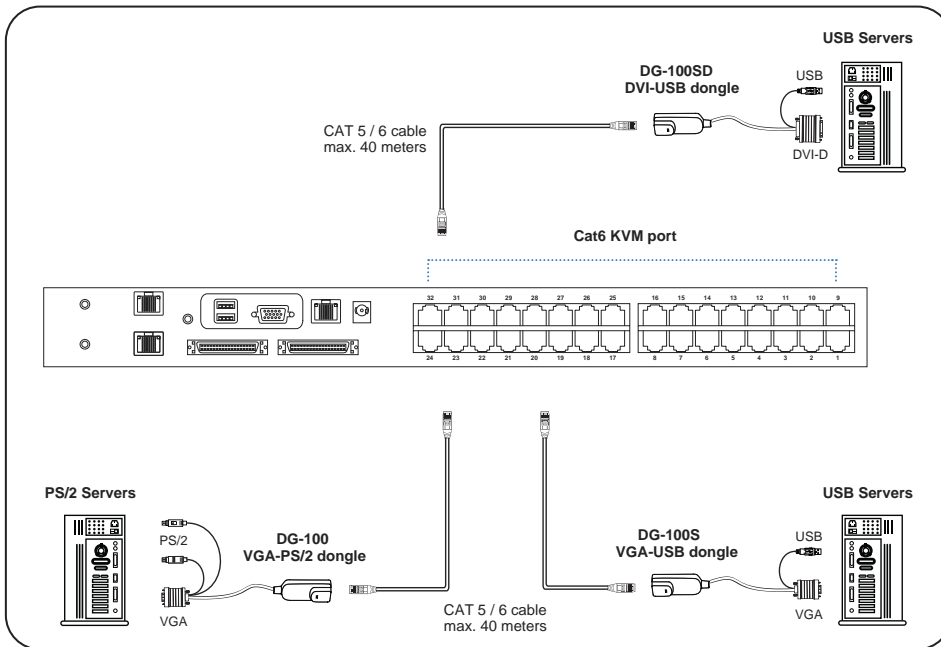

DG-100SD DVI-USB dongle

- To connect DVI-D connector to the computer's video card
- To connect USB connector to the computer's USB port



DG-100S VGA-USB dongle

- To connect DB-15 connector to the computer's video card
- To connect USB connector to the computer's USB port



DG-100 VGA-PS/2 dongle

- To connect DB-15 connector to the computer's video card
- To connect PS/2 keyboard connector to the computer's keyboard port
- To connect PS/2 mouse connector to the computer's mouse port

Cat6 Dongle	EDID Resolution Hard-coded	Resolutions Capable			
		4:3			16:10
		1024 x 768	1280 x 1024	1600 x 1200	1440 x 900
DG-100	1600 x 1200	✓	✓	✓	✓*
DG-100S	1600 x 1200	✓	✓	✓	✓*
DG-100SD	1280 x 1024	✓	✓	✗	✗

* Requires the user to enable showing unsupported resolutions via the target computer's video adapter settings (effectively ignoring the DDC / EDID)

IP, Remote & Local console connection

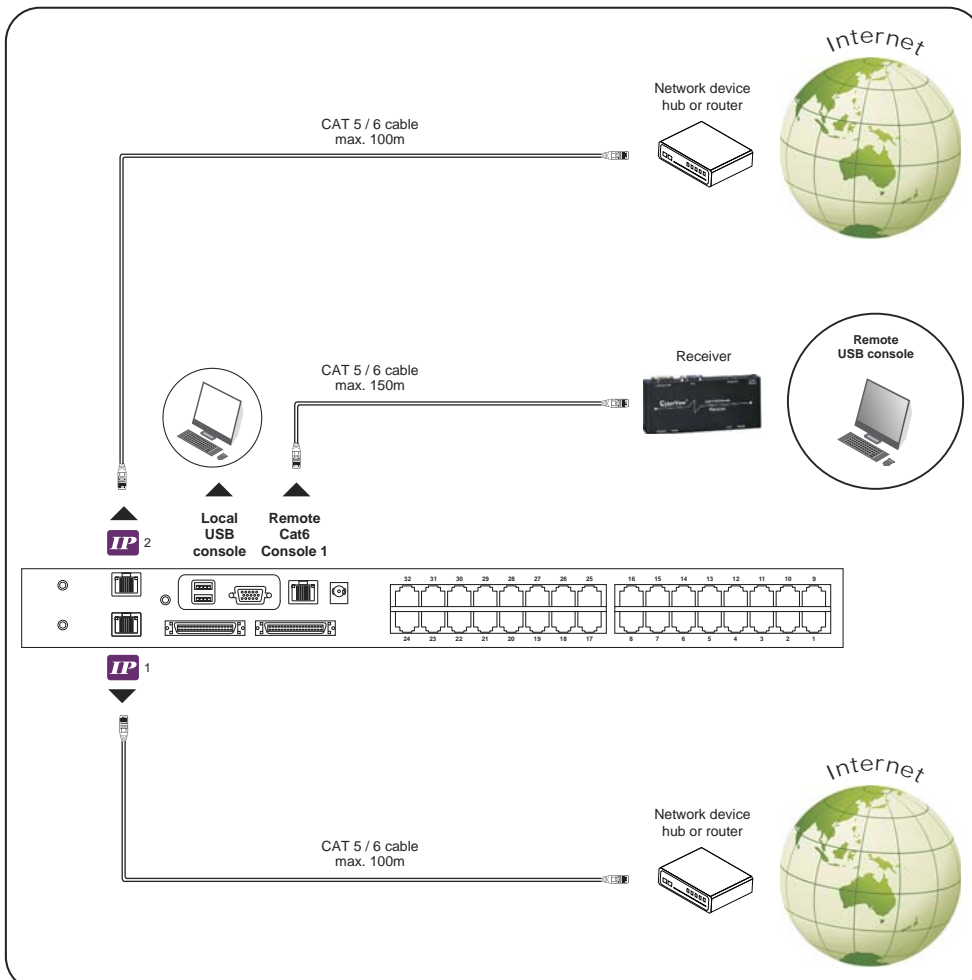

KVM Cascade

- Cascade up to 8 levels, 256 servers
- Cascading multiple KVM with CMC-8 cascade cable.

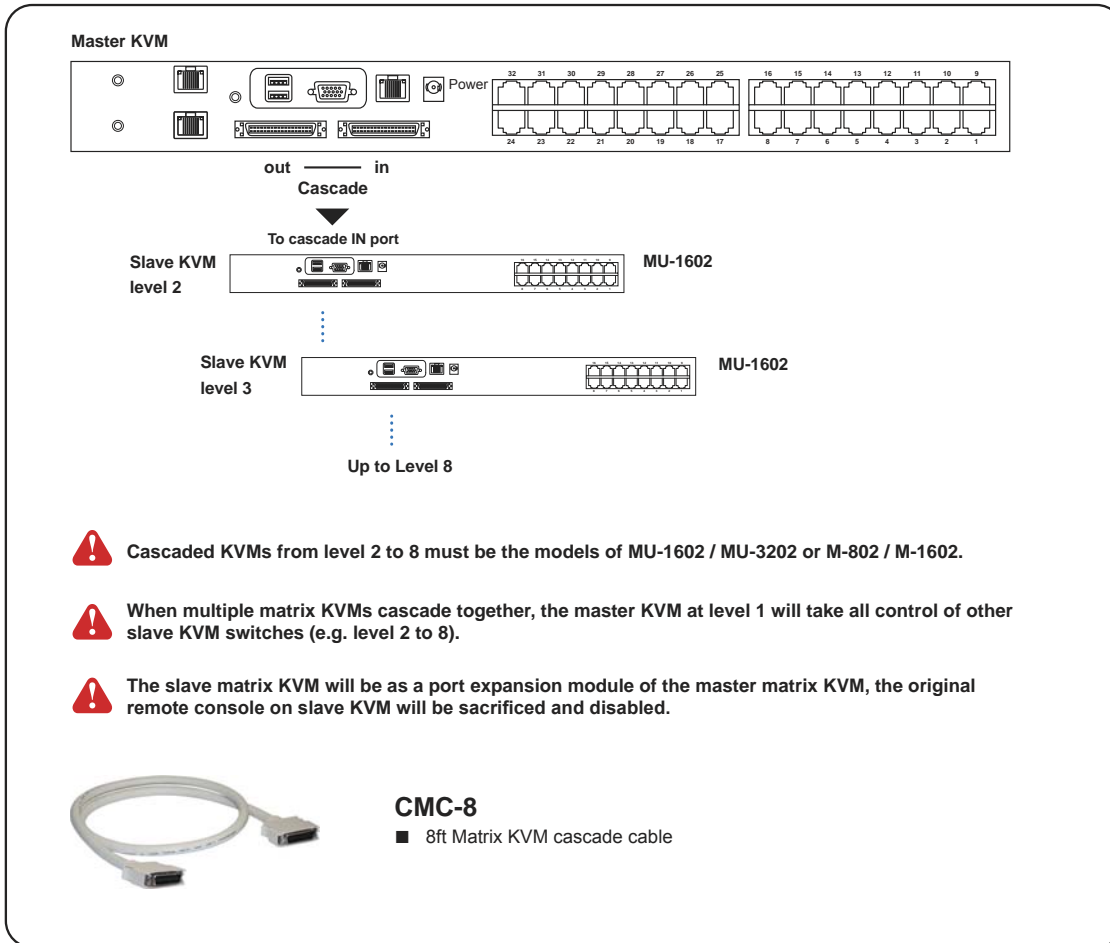

⚠ For detailed product specifications and options, please download the user manual from the link below : www.austin-hughes.com/support/usermanual/cyberview/UM-CV-MUKVM.pdf