

### M-IP813 / 1613 M-IP824 / 1624



#### Matrix DB-15 IP KVM Benefits

- ▶ Secure IP remote user access across the world wide web
- ▶ Efficient system management with simultaneous multi-user access
- ▶ Support resolution up to 1920 x 1080
- ▶ SUN 1152 x 900 resolution compatible
- ▶ Multi-platform servers shared by different consoles in cascade connection
- ▶ Mix PS/2, USB & SUN with Multi-Platform switch capability
- ▶ Extended Cat6 cord remote access up to 150 meters
- ▶ Provide a diversity of consoles to access servers independently & simultaneously

#### Switch Features & Options

- Mix legacy PS/2 servers with newer USB and SUN solutions
- Greater distances between your switch and servers allow enhanced data center rack layouts
- Multi lingual on screen display menu
- Advanced user profiles and configurable OSD hot key combinations

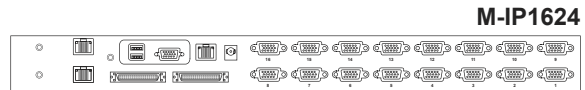
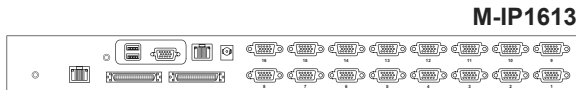
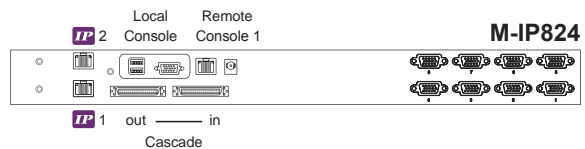
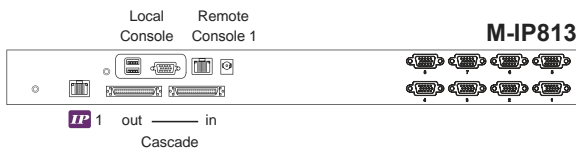

#### Ordering Information

Console	Local	Remote	IP	8-port	16-port
	1	1	1	<b>M-IP813</b>	<b>M-IP1613</b>
	1	1	2	<b>M-IP824</b>	<b>M-IP1624</b>

#### KVM Specification

<b>■ KVM Port</b>	
Number of ports:	8 or 16
Connector:	DB-15 combo connector
Connectivity:	Combo 4-in-1 KVM cable up to 6, 10 & 15 feet
<b>■ Local Console</b>	
Monitor port:	1 x DB-15 VGA ( Up to 1920 x 1080 / 1920 x 1200 )
Keyboard & mouse port:	2 x USB type connector for keyboard & mouse
<b>■ Cat6 Remote Console</b>	
Number of remote port:	1
Monitor port:	DB15-pin VGA ( Up to 1600 x 1200 )
Keyboard & mouse port:	2 x USB type connector for keyboard & mouse
Remote I/O:	RJ45 via Cat5 / Cat5e / Cat6 cable up to 500 feet
<b>■ IP Remote Console</b>	
Number of IP console:	1 for M-IP813 / M-IP1613 2 for M-IP824 / M-IP1624
User management:	15-user login, 1 x active user
Browser:	Internet Explorer, Firefox, Safari
Security:	SSL v3, RSA, AES, HTTP / HTTPS, CSR
IP Access:	RJ45 Ethernet per IP console
<b>■ Expansion:</b>	Up to 240 servers by 8-level cascade

<b>■ Compatibility</b>	
Multi-platform:	Mix PCs, SUN and Mac G3 / G4 Mac / iMac
Support:	Windows 7 / Vista / 2003 / XP, Linux, Unix
<b>■ Power</b>	
Input:	AC power adapter
Consumption:	Max. 48 Watt, Standby 5 Watt
<b>■ Regulatory :</b>	
Safety:	cUL, FCC & CE certified
Environment:	RoHS2 & REACH compliant
<b>■ Environmental</b>	
Operating:	0 to 50°C
Storage:	-5 to 60°C
Relative humidity:	90%, non-condensing
Shock:	50G peak acceleration (11ms, half-sine wave)
Vibration:	58~100Hz / 0.98G (11ms / cycle)
<b>■ Product Information</b>	
Dimension (W x D x H):	443 x 171 x 44 mm / 17.4 x 6.7 x 1.73 inch
Net weight:	3 kg / 6.5 lb
<b>■ Packing Information</b>	
Dimension (W x D x H):	500 x 400 x 90 mm / 19.7 x 15.7 x 3.5 inch
Gross weight:	5 kg / 11 lb

## KVM port connection

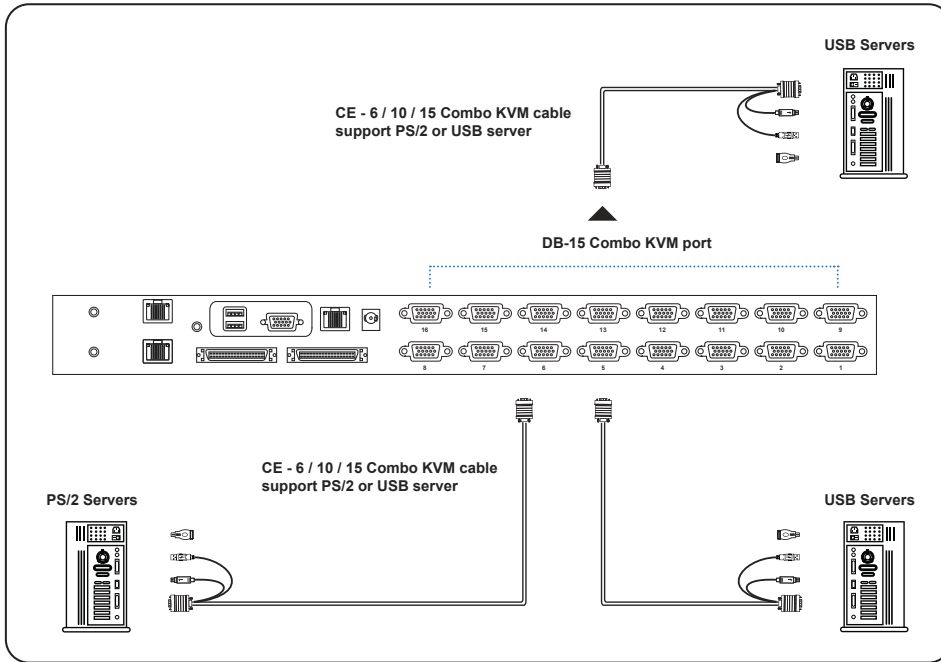

- CE-6 / CE-10 / CE-15**
- 6 / 10 / 15 ft Combo KVM cable
  - Support PS/2 or USB server

## IP, Remote & Local console connection

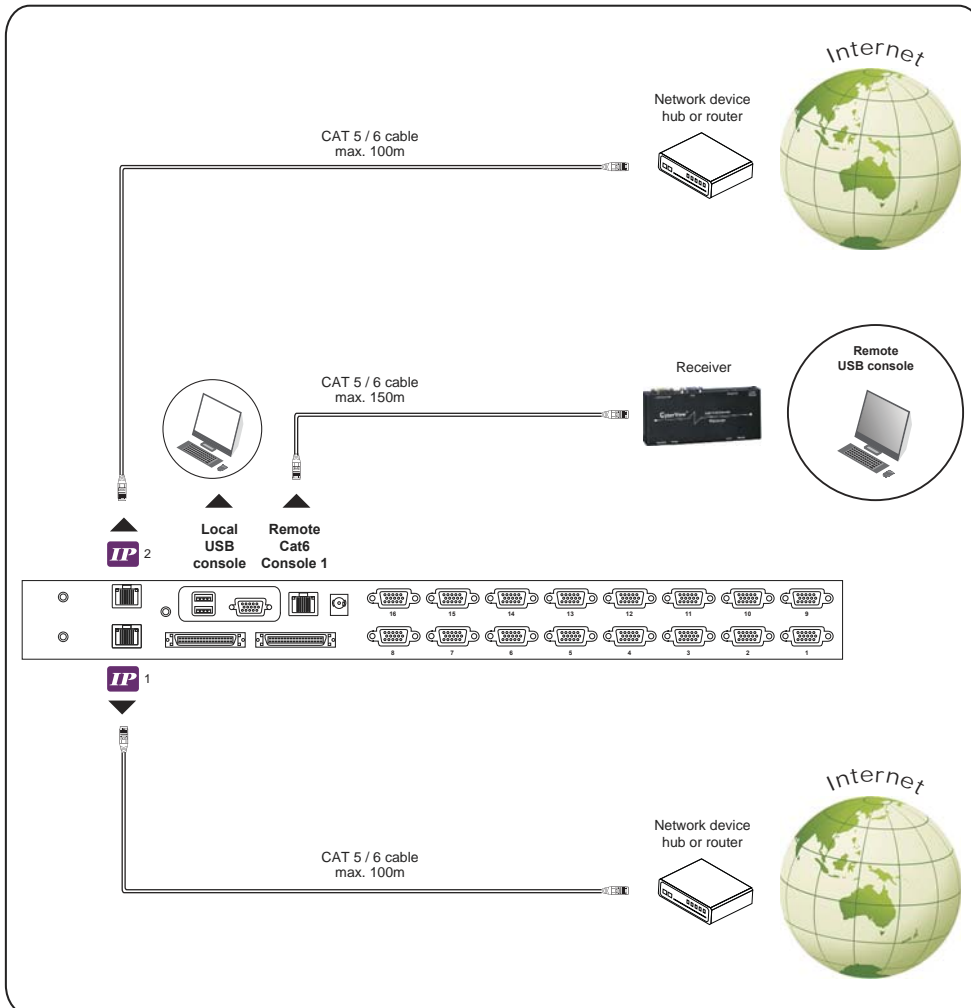

## KVM Cascade

- Cascade up to 8 levels, 240 servers
- Cascading multiple KVM with CMC-8 cascade cable.

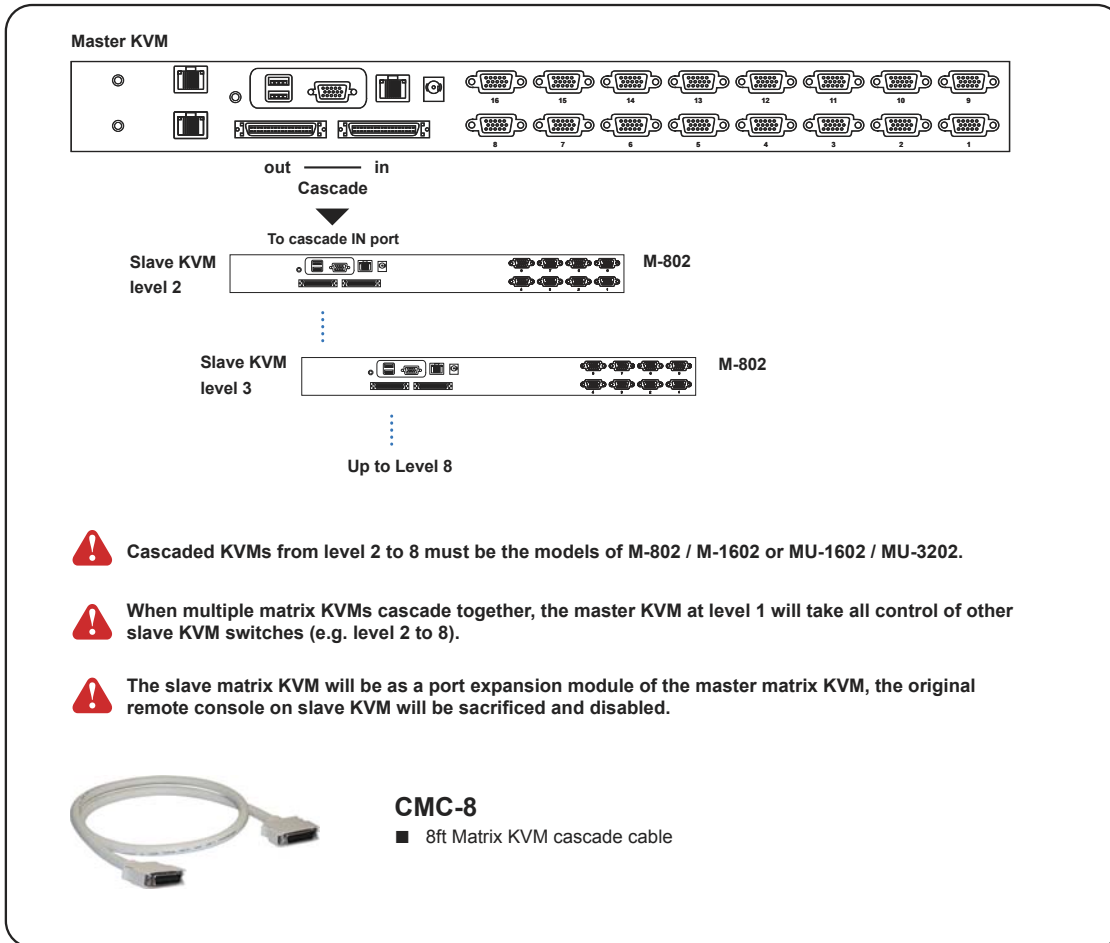

- ⚠ Cascaded KVMs from level 2 to 8 must be the models of M-802 / M-1602 or MU-1602 / MU-3202.
- ⚠ When multiple matrix KVMs cascade together, the master KVM at level 1 will take all control of other slave KVM switches (e.g. level 2 to 8).
- ⚠ The slave matrix KVM will be as a port expansion module of the master matrix KVM, the original remote console on slave KVM will be sacrificed and disabled.

⚠ For detailed product specifications and options, please download the user manual from the link below :  
[www.austin-hughes.com/support/usermanual/cyberview/UM-CV-MKVM.pdf](http://www.austin-hughes.com/support/usermanual/cyberview/UM-CV-MKVM.pdf)